

Article number: 03446180

Description: Fluro Heavy Duty Spherical Plain Bearing GE 180 GW-2RS
Hole Ø180

Note: 180

Measures

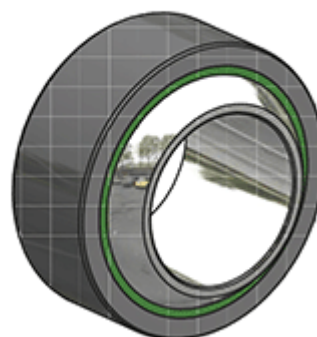
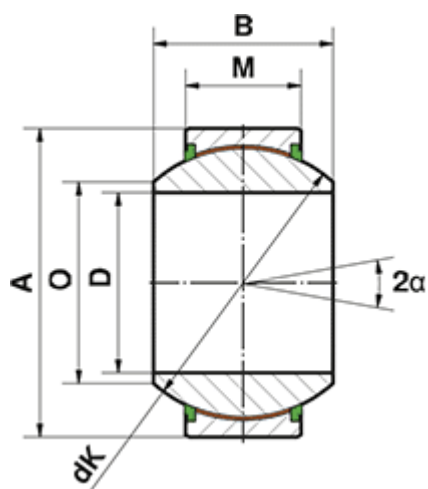

	= -	Dynamic load C (kN) = 6000
	= -	M = 100
	= -	O = 196.1
A	= 290	Static load C0 (kN) = 10000
a (degrees)	= 14	Weight (g) = 33600
B	= 155	
D	= 180	
dK	= 250	